

La resa mista

Schede allegare al post
"La resa mista"



La resa mista

Resa mista 1

Unica fustella con regolazione di stampa ottimale

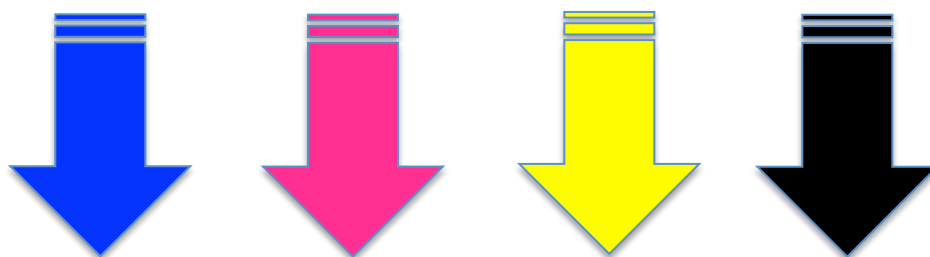



La resa mista

Resa mista 2

Unica fustella con regolazione di stampa critica

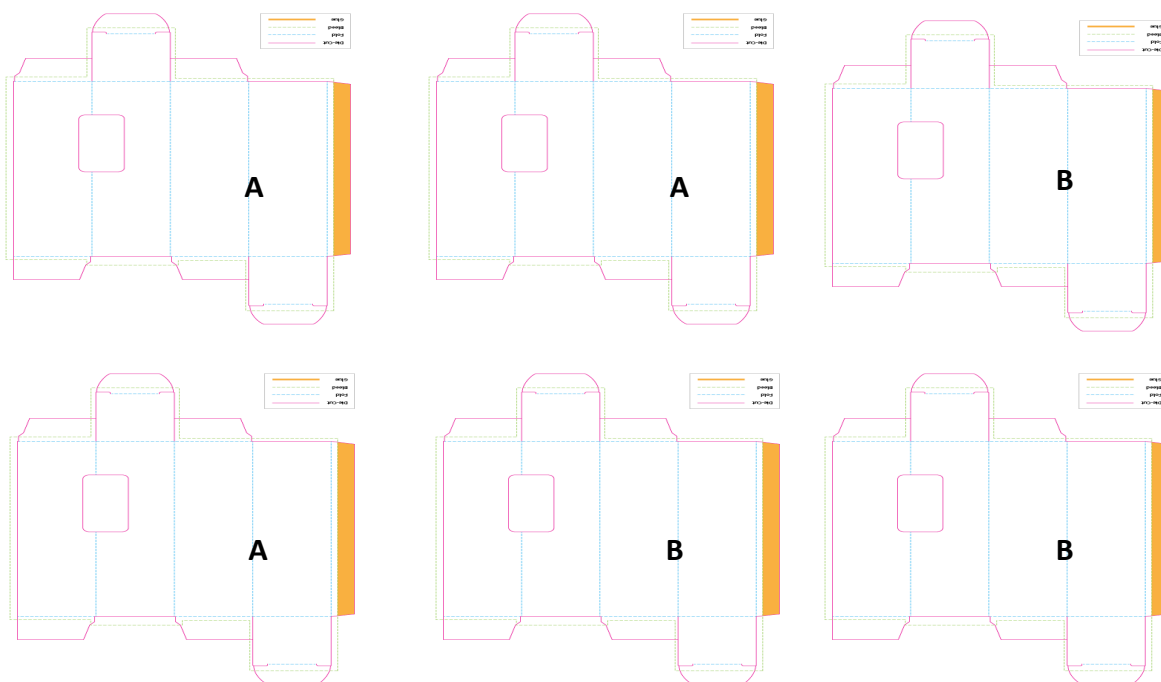
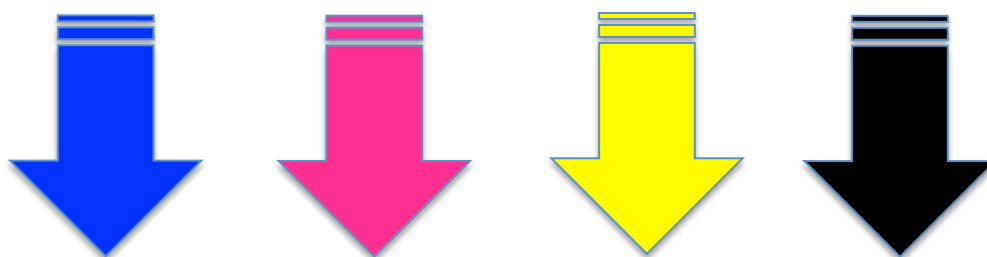



La resa mista

Resa mista 3

Due fustelle con regolazione di stampa ottimale

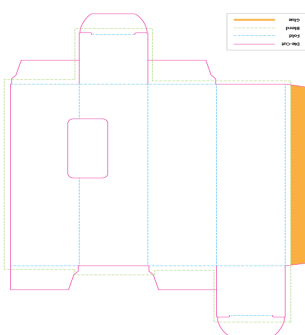
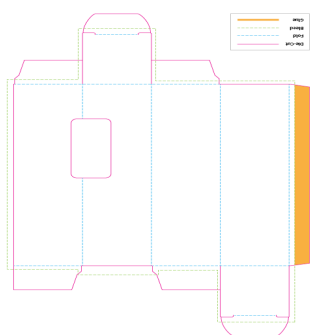
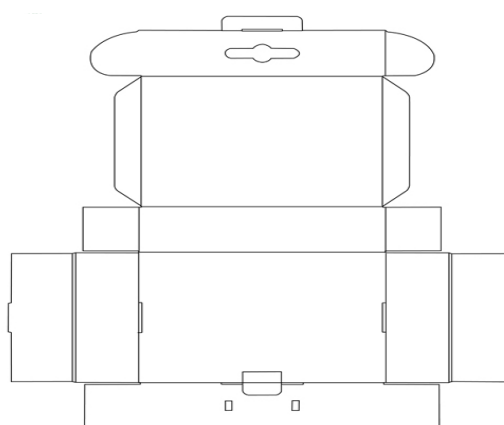
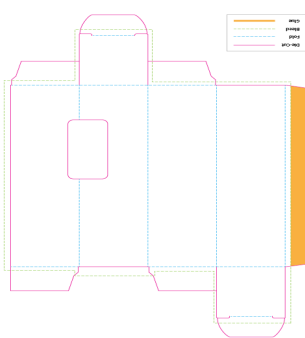
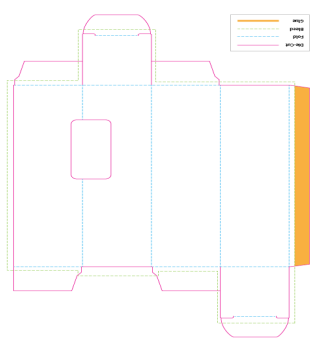
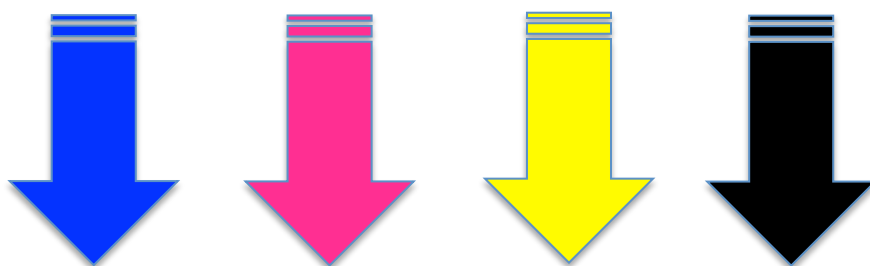

Chi sono

Marco Rotondo,
tecnico-commerciale
e consulente di
marketing operativo.

25 anni di esperienza
maturata nel settore
cartotecnico.

Ha collaborato con
l'Istituto Europeo di
Design sui temi del
Packaging Design.

Tramite il blog
"l'Angolo Rotondo"
sviluppa e
approfondisce gli
aspetti tecnici e di
marketing legati ai
prodotti cartotecnici.

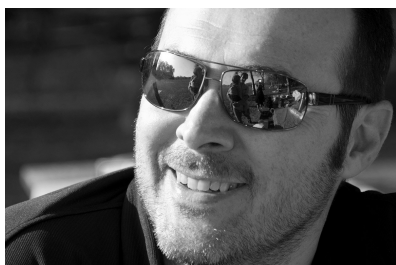

Il mio Blog

www.angolorotondo.it

Linkedin

[https://www.linkedin.com/
pub/marco-rotondo/1/
a99/7b4](https://www.linkedin.com/pub/marco-rotondo/1/a99/7b4)

Twitter

marco_rotondo

Pinterest

[https://www.pinterest.com/
marcorotondo64/](https://www.pinterest.com/marcorotondo64/)

La gallery dei miei prodotti su
Flickr

<https://flic.kr/s/aHsk3qmrr9>